

Caracol Perforado Con Tubo

Ref.	Tipo	A	B	L1	L2	L	E	Ø Eje	Acabado
07.302.060	Peldaño	600	355	70	35	180	3	100	Hierro
07.302.070	Peldaño	700	385	70	35	180	3	100	Hierro
07.302.080	Peldaño	800	430	70	35	180	3	100	Hierro
07.308.060	Rellano	600	900	70	35	180	3	100	Hierro
07.308.070	Rellano	700	1040	70	35	180	3	100	Hierro
07.308.080	Rellano	800	1185	70	35	180	3	100	Hierro

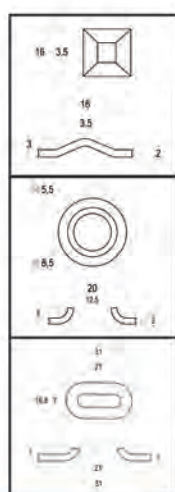

Modelo "A" repujado punta diamante

Modelo "B" perforado redondo

Modelo "C" perforado oval

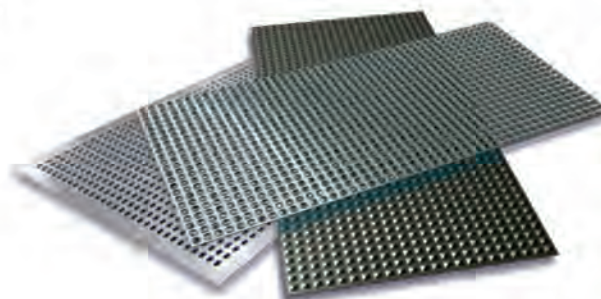

Ref.	Tipo	Medidas	Grosor	Descripción	Modelo	Acabado
07.392.002	Chapa	2000x1000	2 mm	Repujado punta diamante	A	Galvanizado
07.392.012	Chapa	2000x1000	2 mm	Perforado redondo	B	Galvanizado
07.392.030	Chapa	2000x1000	3 mm	Perforado oval	C	Hierro

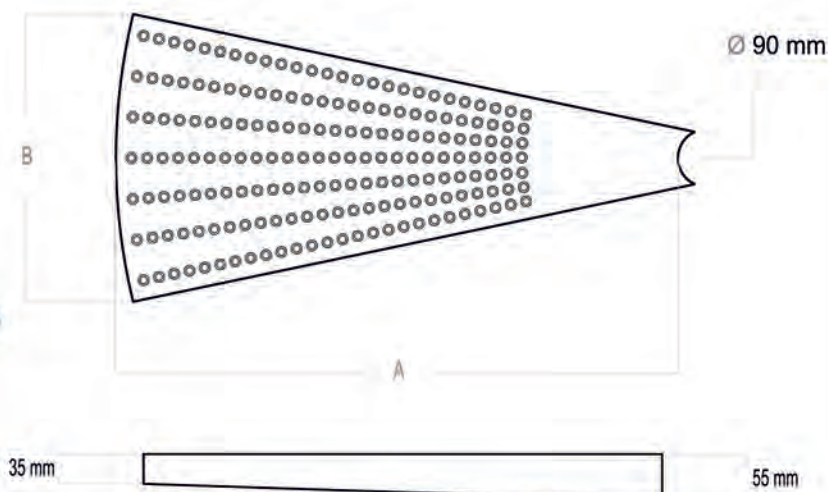

Peldaño Caracol Repujado

Ref.	Tipo	A	B	L1	L2	E	Ø Eje	Acabado
07.312.062	Peldaño	600	350	55	35	2	90	Galvanizado
07.312.072	Peldaño	700	385	55	35	2	90	Galvanizado
07.312.082	Peldaño	800	420	55	35	2	90	Galvanizado

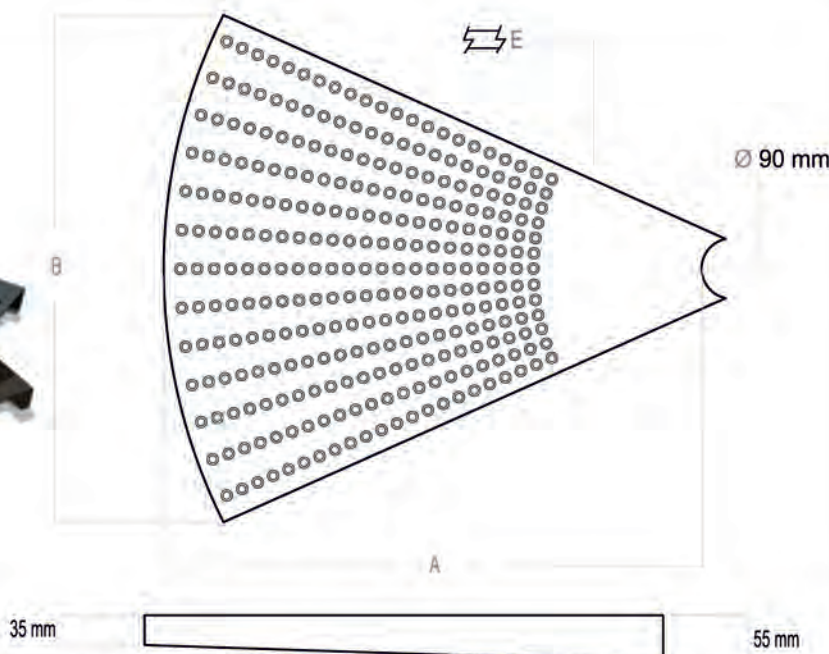
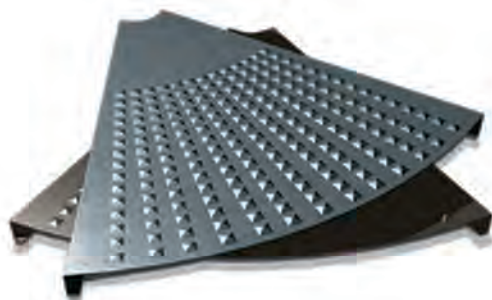
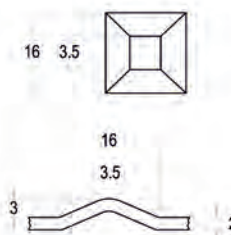

Rellano Caracol Repujado

Ref.	Tipo	A	B	L1	L2	E	Ø Eje	Acabado
07.318.062	Rellano	600	600	55	35	2	90	Galvanizado
07.318.072	Rellano	700	680	55	35	2	90	Galvanizado
07.318.082	Rellano	800	760	55	35	2	90	Galvanizado

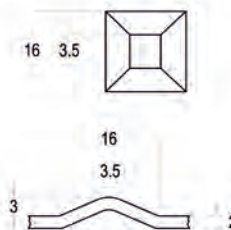

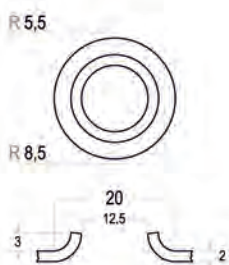
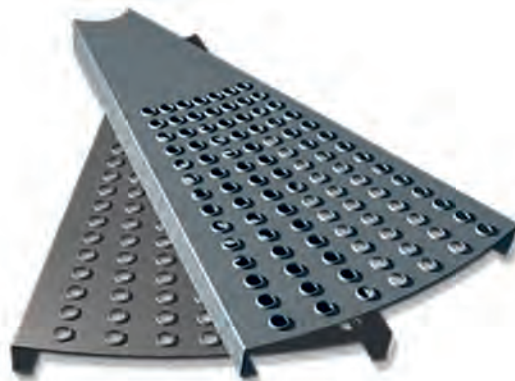
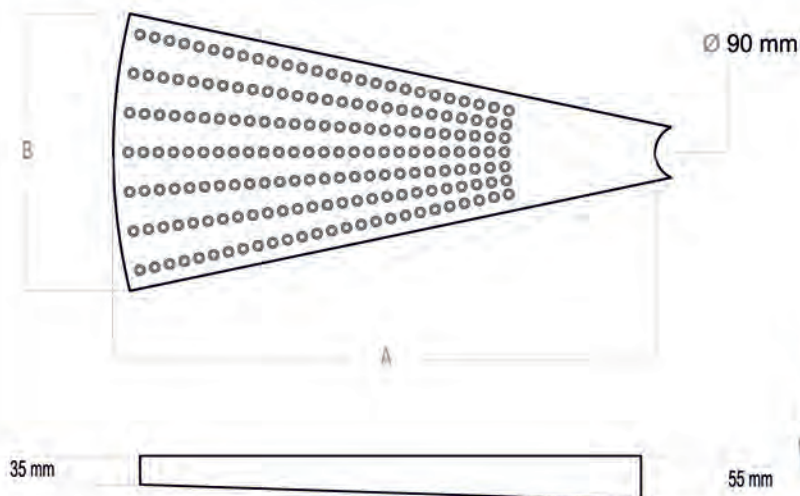

Peldaño Caracol Perforado

Ref.	Tipo	A	B	L1	L2	E	Ø Eje	Acabado
07.322.062	Peldaño	600	350	55	35	2	90	Galvanizado
07.322.072	Peldaño	700	385	55	35	2	90	Galvanizado
07.322.082	Peldaño	800	420	55	35	2	90	Galvanizado

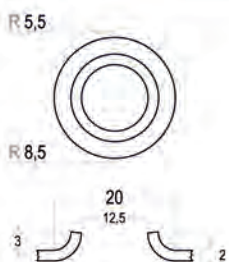
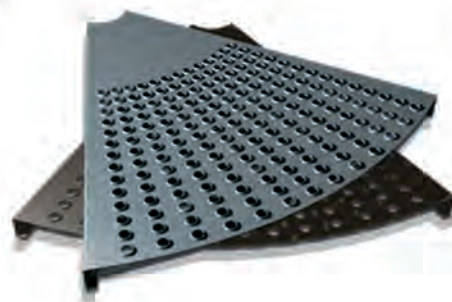
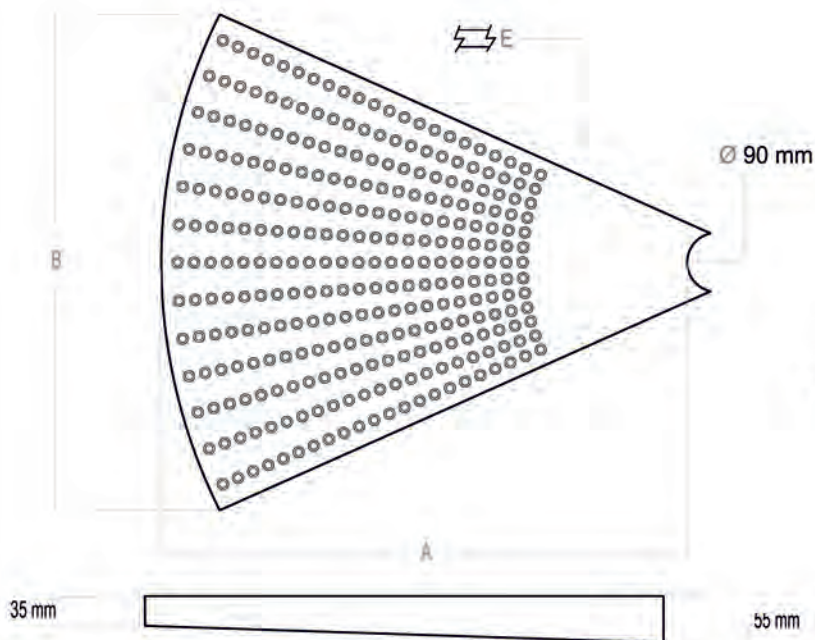

Rellano Caracol Perforado

Ref.	Tipo	A	B	L1	L2	E	Ø Eje	Acabado
07.328.062	Rellano	600	600	55	35	2	90	Galvanizado
07.328.072	Rellano	700	680	55	35	2	90	Galvanizado
07.328.082	Rellano	800	760	55	35	2	90	Galvanizado

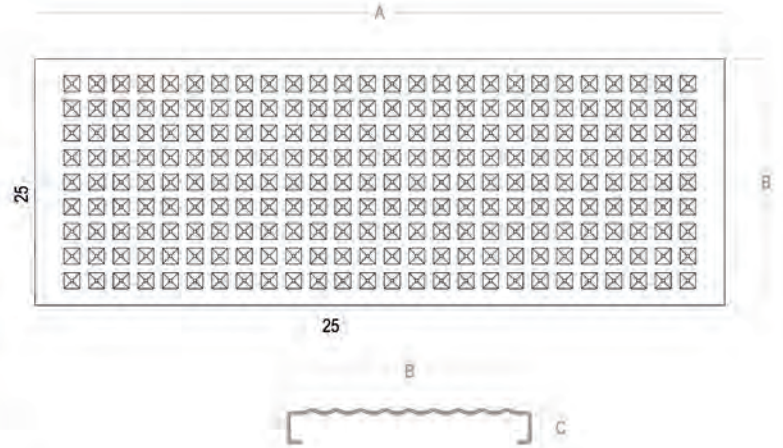
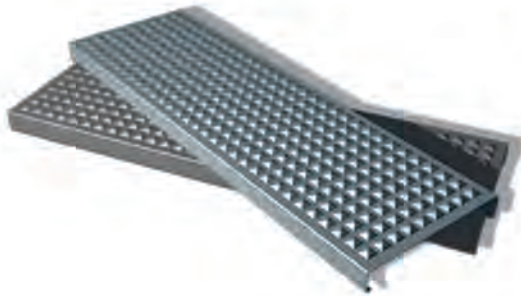

Peldaño Recto Repujado

Ref.	Tipo	A	B	C	Espesor	Acabado
07.362.062	Peldaño	600	250	35	2 mm	Galvanizado
07.362.072	Peldaño	700	250	35	2 mm	Galvanizado
07.362.082	Peldaño	800	250	35	2 mm	Galvanizado
07.362.092	Peldaño	900	250	35	2 mm	Galvanizado
07.362.102	Peldaño	1000	250	35	2 mm	Galvanizado

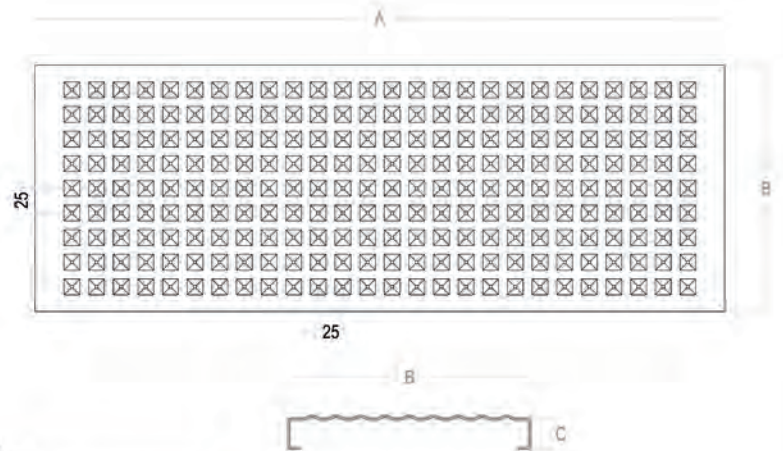
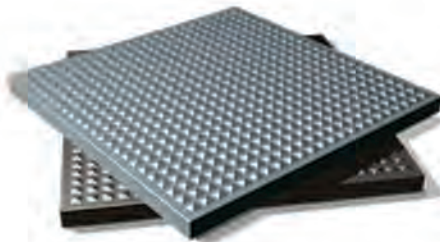
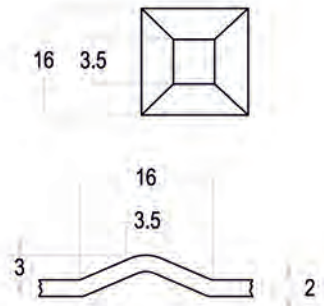

Rellano Recto Repujado

Ref.	Tipo	A	B	C	Espesor	Acabado
07.368.062	Rellano	600	600	35	2 mm	Galvanizado
07.368.072	Rellano	700	700	35	2 mm	Galvanizado
07.368.082	Rellano	800	800	35	2 mm	Galvanizado
07.368.092	Rellano	900	900	35	2 mm	Galvanizado
07.368.102	Rellano	1000	1000	35	2 mm	Galvanizado

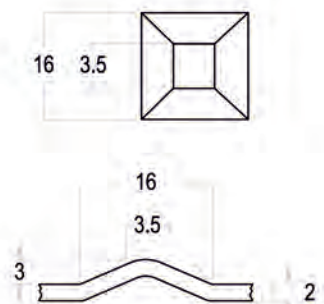

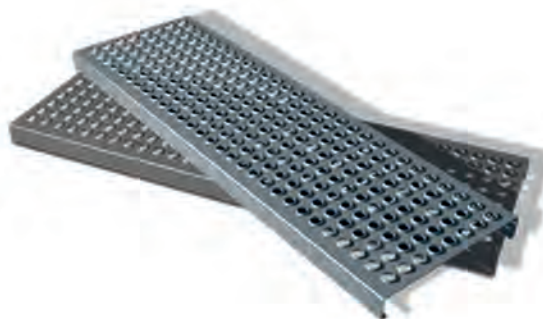
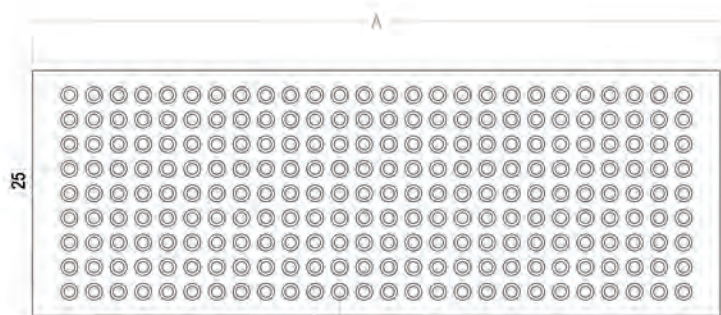

R 5,5

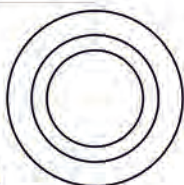

R 8,5

20
12,5



Peldaño Recto Perforado

Ref.	Tipo	A	B	C	Espesor	Acabado
07.372.062	Peldaño	600	250	35	2 mm	Galvanizado
07.372.072	Peldaño	700	250	35	2 mm	Galvanizado
07.372.082	Peldaño	800	250	35	2 mm	Galvanizado
07.372.092	Peldaño	900	250	35	2 mm	Galvanizado
07.372.102	Peldaño	1000	250	35	2 mm	Galvanizado

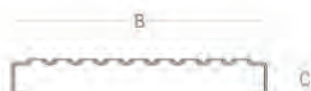
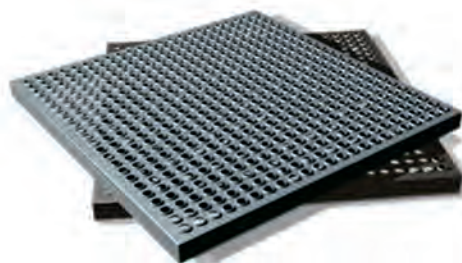
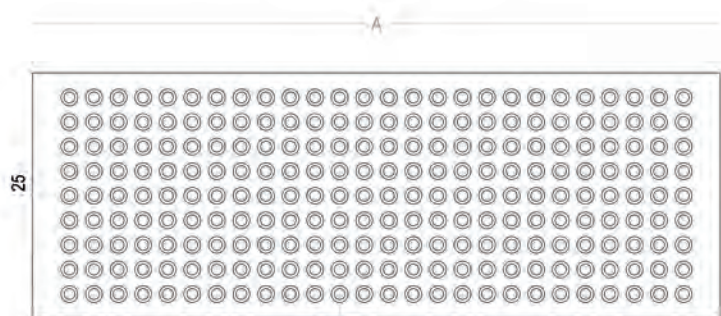

R 5,5

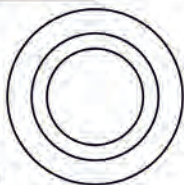

R 8,5

20
12,5



Rellano Recto Perforado

Ref.	Tipo	A	B	C	Espesor	Acabado
07.378.062	Rellano	600	600	35	2 mm	Galvanizado
07.378.072	Rellano	700	700	35	2 mm	Galvanizado
07.378.082	Rellano	800	800	35	2 mm	Galvanizado
07.378.092	Rellano	900	900	35	2 mm	Galvanizado
07.378.102	Rellano	1000	1000	35	2 mm	Galvanizado

Ref.	Tipo	Medidas	Descripción	Acabado
07.394.000	Baranda	930x225x32 mm	Baranda para atornillar	Hierro

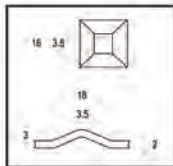

Modelo "A" repujado punta diamante

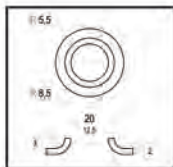

Modelo "B" perforado redondo

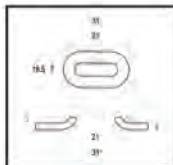

Modelo "C" perforado oval

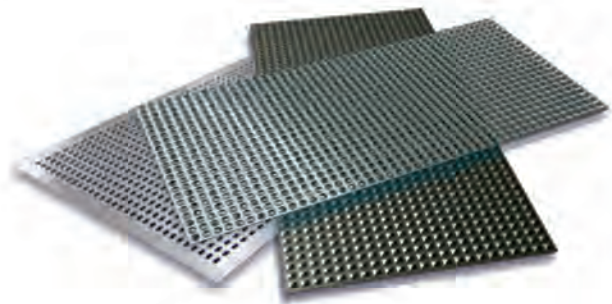

Ref.	Tipo	Medidas	Grosor	Descripción	Modelo	Acabado
07.392.002	Chapa	2000x1000	2 mm	Repujado punta diamante	A	Galvanizado
07.392.012	Chapa	2000x1000	2 mm	Perforado redondo	B	Galvanizado
07.392.030	Chapa	2000x1000	3 mm	Perforado oval	C	Hierro